



Compound school microscope

OBT-1, OBT-2

OBT 101, OBT 102, OBT 103, OBT 104, OBT 105, OBT 106, OBT 231



PROFESSIONAL MEASURING

English version

Operating instructions compound school microscope

Version 1.1
2024-09
en
OBT-1-BA-e-2411.docx

en

You can find other language versions online at

www.kern-sohn.com/manuals

fr

Vous trouverez d'autres versions de langue online sous

www.kern-sohn.com/manuals

bg

Други езикови версии ще намерите в сайта

www.kern-sohn.com/manuals

el

Άλλες γλωσσικές αποδόσεις θα βρείτε στην ιστοσελίδα

www.kern-sohn.com/manuals

hr

Druge jezične verzije su dostupne na stranici :

www.kern-sohn.com/manuals

lv

Citas valodu versijas atradīsiet vietnē

www.kern-sohn.com/manuals

pt

Encontram-se online mais versões de línguas em

www.kern-sohn.com/manuals

sl

Druge jezikovne različice na voljo na spletni strani

www.kern-sohn.com/manuals

en

Further language versions you will find online under

www.kern-sohn.com/manuals

it

Trovate altre versioni di lingue online in

www.kern-sohn.com/manuals

cs

Jiné jazykové verze najdete na stránkách

www.kern-sohn.com/manuals

et

Muud keeleversioonid leiata Te leheküljel

www.kern-sohn.com/manuals

hu

A további nyelvi változatok a következő oldalon található:

www.kern-sohn.com/manuals

nl

You can find the next day's insurance online at

www.kern-sohn.com/manuals

ro

Alte versiuni lingvistice veți găsi pe site-ul

www.kern-sohn.com/manuals

sv

Other language versions can be found here

www.kern-sohn.com/manuals

it

Más versiones de idiomas se encuentran online bajo

www.kern-sohn.com/manuals

pl

Inne wersje językowe znajdują Państwo na stronie

www.kern-sohn.com/manuals

there

Find more sprogudgaver on the website

www.kern-sohn.com/manuals

fi

Muut kieliversiot löytyvät osoitteesta

www.kern-sohn.com/manuals

lt

Kitas kalbines versijas rasite svetainėje

www.kern-sohn.com/manuals

no

Andre språkversjoner finnes det på

www.kern-sohn.com/manuals

sk

Iné jazykové verzie nájdete na stránke

www.kern-sohn.com/manuals



KERN & Sohn GmbH
Ziegelei 1
72336 Balingen-Frommern
Germany



+0049-[0]7433-9933-0



+0049-[0]7433-9933-149



info@kern-sohn.com



www.kern-sohn.com

KERN[®]
OPTICS

KERN Optics OBT-1, OBT-2

Compound school microscope

Operating instructions compound school microscope

Version 1.1 2024-09 English version

Table of contents:

1	Technical data	3
2	Declaration of conformity	5
3	Overview of the device	6
3.1	Nomenclature	6
4	Before use	8
4.1	General information	8
5	Basic information (general)	9
5.1	General information on warnings	9
5.2	Intended use	10
5.3	Improper use	10
5.4	Warranty	10
6	Basic warnings and safety instructions	11
6.1	Observe the notes in the operating instructions	11
6.2	Staff training	11
6.3	Security.....	11
7	Transportation and storage	14
7.1	Note	14
7.2	Transportation	14
7.3	Storage	14
7.4	Packaging/return transportation	14
8	Unpacking and commissioning	15
8.1	Unpacking.....	15
8.2	Initial commissioning	15
9	Assembly	16
9.1	Microscope head	16
9.2	Lenses	16
9.3	Eyepieces	16
9.4	Condenser	17
10	Operation	18
10.1	First steps	18
10.2	(Pre-) focusing	19
10.3	Adjusting the interpupillary distance.....	19
10.4	Diopter compensation.....	20
10.5	Setting the magnification	21
10.6	Setting the lighting.....	22
10.7	Use of oil immersion lenses	23
10.8	Changing the bulb.....	24
10.9	Use of batteries	24
11	Troubleshooting	25
12	Service	27
13	Power supply / battery operation	28

13.1 Mains connection..... 28

14 Maintenance, servicing and disposal..... 29

14.1 Cleaning 29

14.2 Maintenance and repair..... 29

14.3 Waste disposal 30

15 Battery law 31

16 Further information 32

1 Technical data

Kern model	OBT 101	OBT 102	OBT 103	OBT 104
Item number/type	OBT 101	OBT 102	OBT 103	OBT 104
Dimensions (WxDxH)	195x147x325 mm			
Tube type	Monocular	Monocular	Monocular	Binocular
Optical system	Finite			
Revolving nosepiece screw-in positions	3	4	4	5
Lens quality	Achromatic			
Standard objectives	4x 10x 40x			
Eyepiece field width	WF			
Illuminance Transmitted light	1W			
Type of lighting Transmitted light	LED			
Lighting equipment	Transmitted light			
Condenser type	ABBE			
Condenser aperture	1,25			
Input voltage power supply / current [Max]	100 - 240V			
Input voltage device / current [Max]	5V, 1000 mA			
Plug-in power supply type	Plug-in power supply			
Fuse	-			
Focusing mechanism	Coaxial coarse and fine drive			
Packaging dimensions	400x280x195 mm			
Net weight	2.8 kg			
Gross weight	3.4 kg			

Kern model	OBT 105	OBT 106	OBT 231
Item number/type	OBT 105	OBT 106	TOBT 231-A
Dimensions (WxDxH)	195x147x325 mm	195x147x325 mm	182x195x360 mm
Tube type	Monocular	Binocular	Tube LCD display
Optical system	Finite		
Revolving nosepiece screw-in positions	4		
Lens quality	Achromatic		
Standard objectives	4x 10x 40x 100x		
Eyepiece field width	WF	WF	-
Illuminance Transmitted light	3W		
Type of lighting Transmitted light	LED		
Lighting equipment	Transmitted light		
Condenser type	ABBE		
Condenser aperture	1,25		
Input voltage power supply / current [Max]	100 - 240V		
Input voltage device / current [Max]	5V, 1000mA	5V, 1000mA	5V, 2A
Plug-in power supply type	Plug-in power supply		
Fuse	-		
Focusing mechanism	Coaxial coarse and fine drive		
Packaging dimensions	400x280x195 mm	400x280x195 mm	535x280x195 mm
Net weight	2.8 kg	2.8 kg	2.3 kg
Gross weight	3.4 kg	3.4 kg	3.1 kg

2 Declaration of conformity

The current EC/EU Declaration of Conformity can be found online at:

<https://www.kern-sohn.com/shop/de/DOWNLOADS/>

3 Overview of the device

3.1 Nomenclature

Example OBT 106 (binocular, mechanical stage)

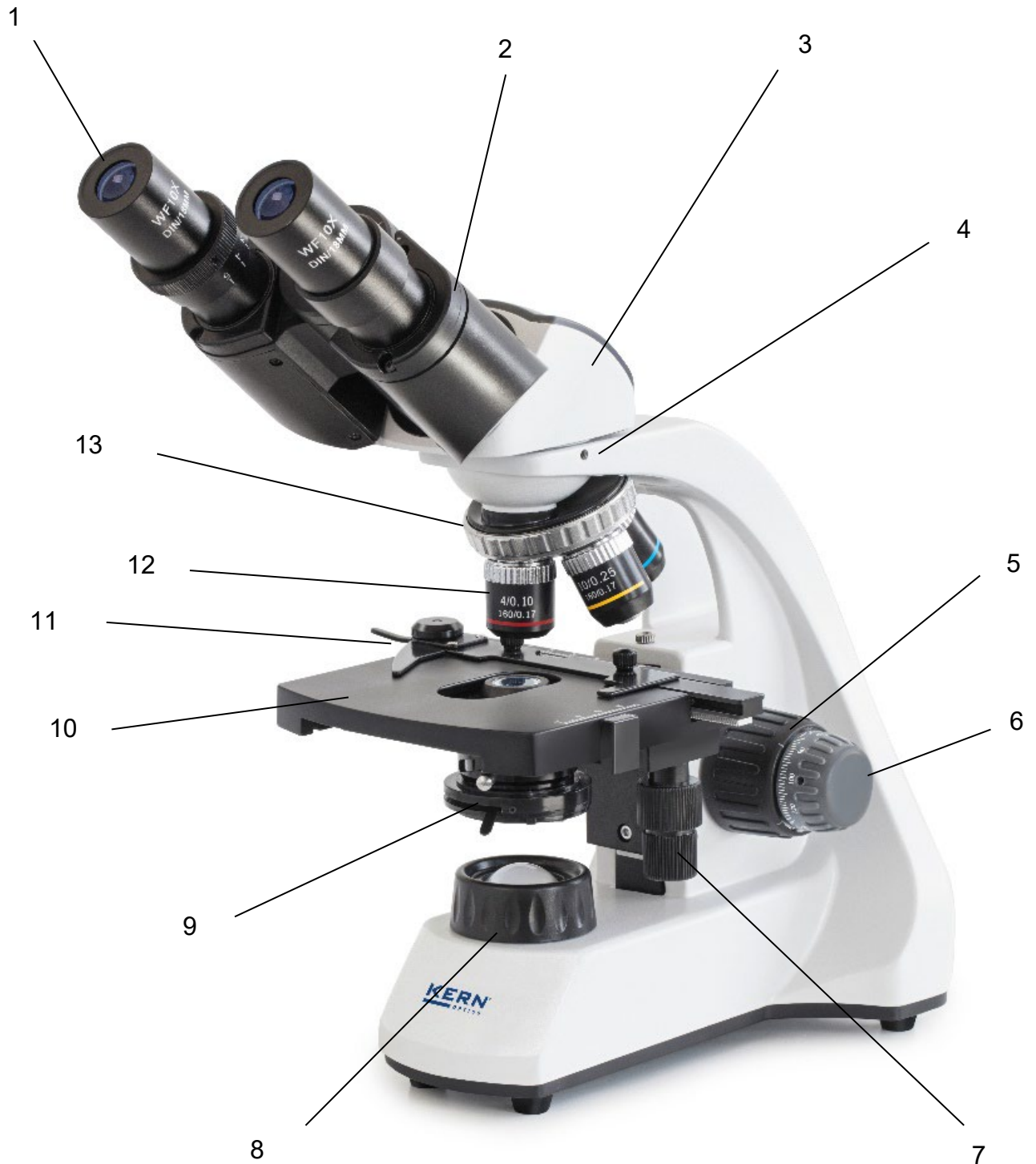

	Description
1	Eyepiece
2	Tube connectors with dioptre adjustment ring
3	Microscope head / tube
4	Locking screw head
5	Coarse drive
6	Fine drive
7	Setting wheel x - y axis Object table
8	Field lens
9	Condenser with aperture adjustment
10	Object table
11	Object holder
12	Objective
13	Nosepiece

4 Before use

4.1 General information

The packaging must be opened carefully to prevent the accessories inside from falling to the floor and breaking.

In general, a microscope should always be handled with great care, as it is a sensitive precision instrument. Avoiding abrupt movements during operation or transportation is therefore particularly important, especially to avoid endangering the optical components.

You should also avoid dirt or fingerprints on the lens surfaces, as in most cases this impairs the sharpness of the image.

If the performance of the microscope is to be maintained, it must never be disassembled. Parts such as objective lenses and other optical components should therefore be left as they are at the start of operation.







5 Basic information (general)

5.1 General information on warnings

Warnings are used in these operating instructions to warn you of possible personal injury or damage to property in certain situations.

Signal word	Description
DANGER	Failure to observe the instructions will lead directly to serious injury, permanent impairment (e.g. loss of a limb) or death of the user or third parties
WARNING	Failure to observe the instructions may result in serious injury, permanent impairment (e.g. loss of a limb) or death of the user or third parties
CAUTION	Failure to observe the instructions may result in minor injuries or temporary damage to the user or third parties (e.g. minor cuts)
NOTE	Failure to observe the instructions may result in damage to property

Symbols in warning notices :

Icon	Meaning
Warnings	Warning signs warn you of dangers that could lead to injury. The symbol indicates the type of danger.
	Indicates general hazards or a danger point
	Warning of electrical voltage
	Warning of optical radiation
	Indicates electrostatic sensitive devices
	Warning of flammable substances
	Warning of explosive substances

Icon	Meaning
Commandment sign	Mandatory signs prescribe measures that you must take to avoid personal injury or damage to property. The symbol indicates the necessary actions or objects to prevent damage.
	Indicates a prescribed action

5.2 Intended use

The OBT-1 and OBT-2 are mainly used for the analysis of translucent and thin, high-contrast, less demanding specimens (e.g. plant tissue, stained cells and parasites).

5.3 Improper use

Do not use the device in potentially explosive atmospheres or for measurements in liquids or on live parts.

Unauthorized structural changes, additions and conversions to the appliance are prohibited.

5.4 Warranty

The guarantee expires in the event of

- Non-compliance with our specifications in the operating instructions
- Use outside the described applications
- Changing or opening the device
- Mechanical damage and damage caused by media, liquids, natural wear and tear
- Improper set-up or electrical installation
- Improper assembly or electrical installation

6 Basic warnings and safety instructions

6.1 Observe the notes in the operating instructions



Read the operating instructions carefully before commissioning/using the device, even if you already have experience with KERN devices. Always keep the instructions in the immediate vicinity of the appliance.

6.2 Staff training

The appliance may only be used by persons who have read and understood the operating instructions, in particular the chapter on safety.

6.3 Security

⚠ WARNING	
	<p>Read all safety information and instructions. Failure to observe the safety information and instructions may result in electric shock, fire and/or serious injury.</p> <p>Keep all safety information and instructions for future reference.</p> <ul style="list-style-type: none">● The design of the device must not be modified. This can lead to incorrect measurement results, safety defects and destruction of the device● Do not operate the appliance in potentially explosive rooms or areas and do not install it there.● Do not operate the device in an aggressive atmosphere.● Do not immerse the appliance in water. Ensure that no liquids penetrate the inside of the device. <p>The device may only be used in a dry environment and under no circumstances in rain or relative humidity above the operating conditions.</p> <ul style="list-style-type: none">● Protect the device from permanent direct sunlight.● Do not expose the appliance to strong vibrations.● Do not remove any safety signs, stickers or labels from the device. Keep all safety signs, stickers and labels in a legible condition● Do not open the device● The lamp generates a lot of heat during operation. Avoid touching the lamp housing during operation and for some time afterwards.● Do not operate the device in an aggressive atmosphere

⚠ WARNING



Risk of injury due to electric shock!

- Risk of short circuit due to penetration of liquids into the housing!
- Do not immerse the appliance or accessories in water. Make sure that no water or other liquids get into the housing.
- Work on electrical components may only be carried out by an authorized specialist company!
- Take care not to twist or kink the mains cable.
- Only use the original adapter supplied

⚠ WARNING



There is a risk of suffocation!

Do not leave the packaging material lying around carelessly. It could become a dangerous toy for children. The appliance is not a toy and does not belong in the hands of children.

- This device can be dangerous if it is used improperly or not as intended by untrained persons! Observe the personnel qualification!

⚠ WARNING



Electrostatic sensitive device!

- The device can be destroyed by electrostatic discharge. Connectors for HF signals are particularly at risk.
- Please observe the handling instructions for electrostatically sensitive components.

⚠ WARNING

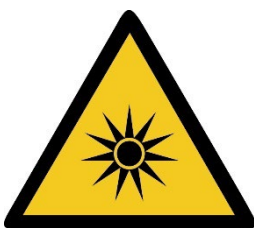

There is a risk from optical radiation!

Gas discharge lamps, LED lights and other white light sources generate intense optical radiation, including UV (ultraviolet), visible light (VIS) and IR (infrared). This radiation can cause both skin and eye damage. The extent of the damage is determined by the wavelength, the duration of exposure and the operating mode (continuous or pulsed).

- Do not expose your eyes and skin to radiation.
- Do not insert any reflective objects into the beam entrance.
- Use suitable protective equipment/protective clothing if necessary.
- Never remove the cover or cladding during operation.
- Never look into the eyepieces when the beam path is open (using the control lever for illumination) and an empty filter position is selected on the FL module. There is an acute risk of blindness here.

⚠ WARNING



Improper use of rechargeable batteries or batteries can cause them to catch fire, explode, emit toxic fumes or release corrosive liquids. The following therefore applies to rechargeable and non-rechargeable batteries:

- Protect from fire and heat.
- Never expose to high pressure or microwaves.
- Do not bring into contact with liquids or chemicals.
- Never bring the electrical contacts of rechargeable batteries and batteries into contact with metal objects or short-circuit them.
- Never modify rechargeable batteries, batteries and chargers.
- Batteries must never be charged.
- Never use or charge a defective, damaged or deformed battery.

CAUTION

Keep a sufficient distance from heat sources.

Do not use the device in environments with high humidity or water mist

! NOTE

- To avoid damaging the device, do not expose it to extreme temperatures, extreme humidity or moisture.
- Do not use abrasive cleaners, scouring agents or solvents to clean the appliance.

7 Transportation and storage

7.1 Note

If you store or transport the device improperly, the device may be damaged. Observe the information on transporting and storing the appliance.

7.2 Transportation

We recommend using the original packaging for shipping, transportation or storage of the microscope components. To prevent damage from shocks, all moving parts that can be assembled and disassembled must be packed separately.

7.3 Storage

Avoid exposing the device to direct sunlight, high or low temperatures, shocks, dust and high humidity.

The suitable temperature range is 0 - 40 °C and a relative humidity of 85% should not be exceeded.

The appliance should always be placed on a firm, smooth and horizontal surface.

When the microscope is not in use, it is best to cover it with the dust cover supplied. Dust or dirt inside the optics of a microscope can in many cases lead to irreversible malfunctions or damage.

Accessories consisting of optical elements, such as additional lenses, are preferably stored in a drying box with desiccant.

7.4 Packaging/return transportation

Returns are only possible within the limits of the general terms and conditions. Keep all parts of the original packaging for any necessary return transportation.

- Only the original packaging is to be used for return transportation.
- Disconnect all connected cables and loose/movable parts before shipping.
- Refit any transportation locks provided.
- Secure all parts against slipping and damage.

8 Unpacking and commissioning

8.1 Unpacking



In the event of a return, please observe the instructions in the chapter "Packaging/return transportation"

On receipt of the device, you should first check that no damage has occurred during transportation, that the outer packaging, the housing, other parts or even the device itself have not been damaged. If any damage is evident, please notify KERN GmbH immediately.

8.2 Initial commissioning

To ensure the function of the microscope, it must be cleaned as described in chapter 9.

9 Assembly

9.1 Microscope head

9.1.1 OBT 101 -106

The microscope head is already attached to the back of the device in the packaging. To use the microscope correctly, the head must be turned to the front.

If the head is to be completely removed (loosen the locking screw beforehand), always ensure that the lenses are not touched with bare fingers and that no dust enters the openings.

9.1.2 OBT 231

The ODC 231 microscope camera is stored in separate packaging. To use it on the microscope, open the locking screw on the side and place the ODC 231 microscope camera on the microscope in the opening provided. Tighten the locking screw to secure the microscope camera. Read the operating instructions carefully before using the ODC 231 microscope camera. The operating instructions can be found in the packaging of the microscope camera.

9.2 Lenses

All standard lenses are already screwed onto the nosepiece. After removing the protective film, the objectives are ready for use. They are arranged in such a way that the objective with the next highest magnification appears when the nosepiece is turned clockwise. If the objectives are unscrewed, care must be taken to ensure that the lenses are not touched with bare fingers and that no dust enters the openings. For objectives marked "OIL", an immersion oil with the lowest possible inherent fluorescence effect must be used.

9.3 Eyepieces

For binocular devices, eyepieces with the same magnification for both eyes must always be used. These are already attached to the tube socket and fixed in place with a screw so that they can be turned but not pulled out. To remove them, loosen the small silver screw underneath the eyepiece on the tube socket. You should always make sure that you do not touch the lenses with your bare fingers and that no dust gets into the openings.

9.4 Condenser

The condenser is firmly fixed to a retaining ring (condenser carrier) below the stage. The lever for the aperture diaphragm points to the front. The height of the condenser can be adjusted, but it cannot be centered.

If you press the silver lever on the side of the condenser, it can be moved up or down. You should always avoid touching the optical lenses with your bare fingers.

10 Operation

10.1 First steps

The first thing to do is to **connect the power supply using the mains plug**. After **switching on the lighting using the main switch**, you should first set the **light intensity** (using the dimmer) to a **low level** so that your eyes are not immediately exposed to too much light when you look into the eyepieces for the first time.

The next step is to **place a microscope slide** with a sample on the microscope stage. The cover glass must be facing upwards for this. The slide can be fixed to the stage using the slide holder (*see illustration on the left*). Depending on the design of the stage, the slide is moved manually (OBT 101, OBT 102) or via the adjustment wheels (OBT 103-106) to the correct position (in the beam path). (*see illustration on the right*). A maximum of one slide can be placed.

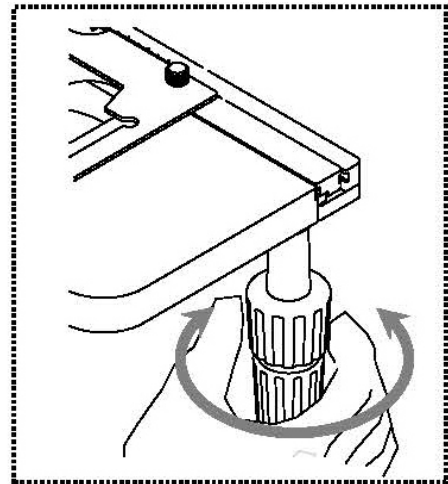
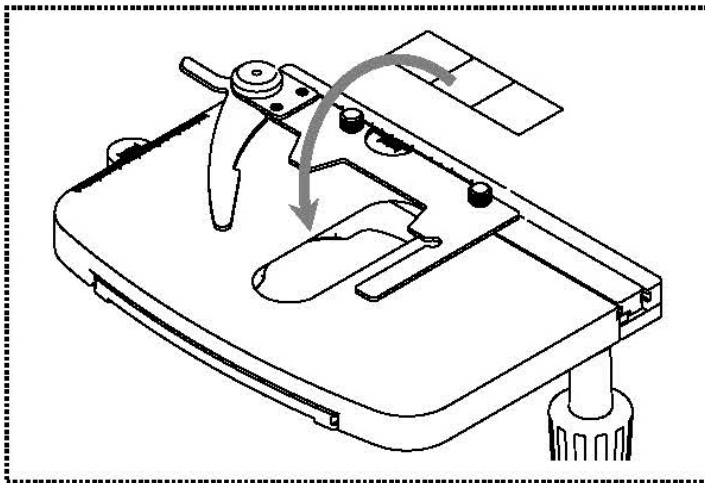

10.2 (Pre-) focusing

When you are observing an object, you must have the correct distance to the objective to achieve a sharp image. In order to find this distance at the beginning (without other default settings of the microscope) place the objective with the lowest magnification in the beam path, look through the right eyepiece with the right eye and turn it slowly using the coarse adjustment knob (see illustration).

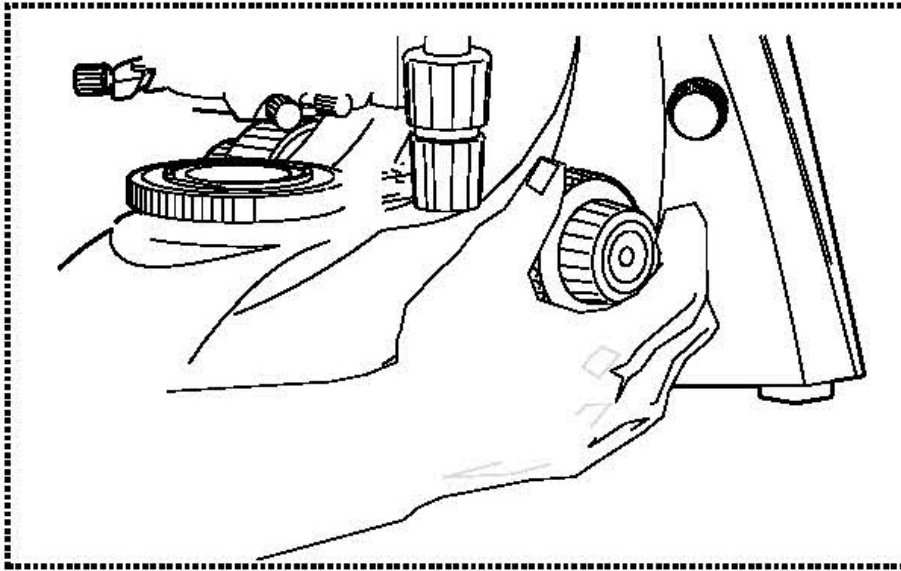

The simplest way of doing this would be to first raise the specimen stage (using the coarse adjustment knob) until it is just under the objective and then lower it slowly. As soon as an image is recognisable (no matter how sharp), then you should only adjust the focus using the fine adjustment knob.

10.3 Adjusting the interpupillary distance

With binocular viewing, the interpupillary distance must be adjusted accurately for each user, in order to achieve a clear image of the object. While you are looking through the eyepieces, use your hands to hold the righthand and lefthand tube housing firmly. By pulling them apart or pushing them together, you can either increase or reduce the interpupillary distance (see illustration). As soon as the field of views of the lefthand and righthand eyepieces completely overlap each other, i.e. they combine to form a circular image, then the interpupillary distance is set correctly.

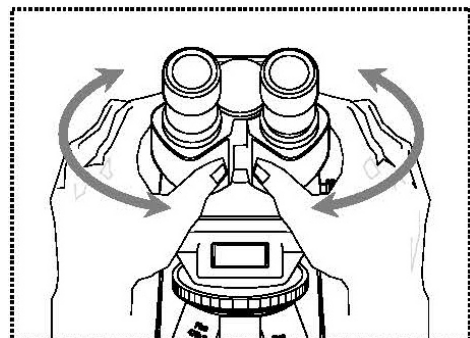

10.4 Diopter compensation (for binocular devices)

The visual acuity of a person using the microscope can very often show minor differences, which have no consequences in everyday life, but can cause problems with precise focusing when using the microscope.

This difference can be compensated as follows via a mechanism on the left tube socket (diopter compensation ring).

1. Look through the right eyepiece with the right eye and focus the image using the coarse and fine drive.
2. Now look through the left eyepiece with your left eye and focus the image using the diopter compensation ring.
To do this, turn the ring in both directions (*see illustration*) to find out at which position the image appears sharpest.

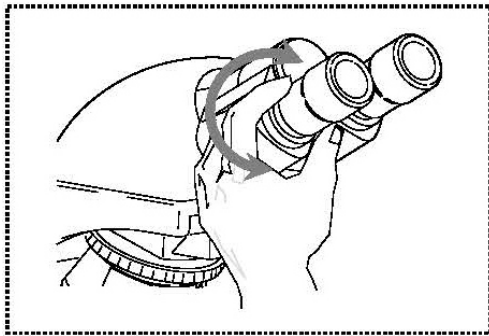

10.5 Setting the magnification

After prefocussing has been carried out using the objective with the lowest magnification (see section 5.2), you can then adjust the overall magnification using the nosepiece, as necessary. By turning the nosepiece you can bring any one of the four other objectives into the beam path.

When adjusting the nosepiece, you must take the following points into account:

- The required objective must be properly locked in place at all times.
- The nosepiece should not be rotated by holding individual objectives, you should use the silver ring above the objectives (see illustration).

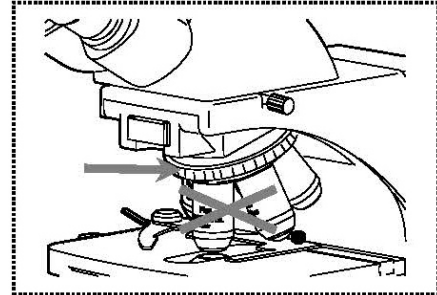

- When rotating the nosepiece you must always make sure that the objective which is about to be positioned in the beam path does not touch the object holder. This can lead to significant damage to the objective lens. We recommend that you always check from the side to make sure that there is sufficient leeway. If this should not be the case, the specimen stage must be lowered accordingly.

If you have focussed the object to be observed for a specific magnification, then if you select the objective with the next greatest magnification, then the object will be slightly out of focus. Use the fine adjustment knob to make a slight adjustment and restore the focus

10.6 Setting the lighting

In order to obtain perfect image results during microscopic observation, it is important that the microscope's light guidance is optimized.

The control element that plays the most important role in the OBT series is the height-adjustable condenser with aperture diaphragm.

For the first lighting setting, the smallest possible lens magnification must be selected before the following steps can be carried out.

1. Adjust the height of the condenser by rotating it around the vertical axis so that the image has a suitable contrast. As a rule, the condenser is brought to just below the maximum height for this purpose.

2. This can be further refined with the aperture diaphragm of the condenser, because by adjusting its lever you try to find the optimum compromise between contrast and resolution for the microscopic image. For the objective with the lowest magnification, the lever must be almost all the way to the right so that the aperture diaphragm has a rather small opening. The higher the magnification of the objective, the larger the aperture diaphragm opening should be and the lever should be moved to the left accordingly.

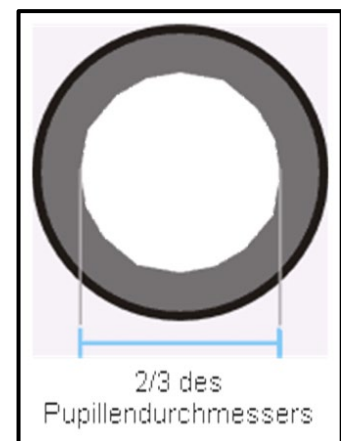

The view into the tube, without the eyepiece, should look something like the illustration on the right.

The diameter of the then visible aperture diaphragm should be about 2/3 of the pupil diameter.

When removing the eyepiece during this check, make absolutely sure that no dirt or dust can enter the tube.

3. The brightness is always adjusted via the lamp brightness (using the dimmer) and not via the aperture diaphragm.

10.7 Use of oil immersion lenses

The 100x objectives of the OBT series are objectives that can be used with oil immersion (they are always labeled "OIL"). This generates a particularly high resolution of the microscopic image.

To use the oil immersion correctly, the following steps must be carried out.

1. Place a drop of oil on the cover slip (with a standard thickness of 0.17 mm) of the preparation.
2. Lower the stage and bring the 100x objective into the beam path.
3. Very slowly move the specimen stage or the specimen towards the objective until light contact is made.
4. Observe object.

The specimen and lens must not be pressed together. The oil is the contact layer.

If the contact is made too abruptly, it is possible that air bubbles in the oil cannot escape. This would impair the clarity of the image.

After use or before changing the preparation, the components that have come into contact with the oil must be thoroughly cleaned. See *chapter Maintenance and cleaning*.

10.8 Changing the bulb

Before changing the bulb, the device must be switched off and unplugged.

To change the bulb, the housing of the field lens needs to be completely unscrewed. The LED can simply be pulled out of its socket. It is mounted into a housing that includes plug connectors (see illustration).



In case of a defect, please contact your KERN dealer or our Technical Department for the required replacement parts.

It is absolutely important to be aware of its correct alignment when mounting the new LED.

Pay attention to the indicated polarity (+/-) both on the housing of the LED (see illustration) and on the microscope's lamp socket.



10.9 Use of batteries

In order to use batteries as power supply you have to open the battery compartment on the bottom of the bottom of the microscope (loosen allen screw at first). You require 3x 1.5V AA batteries to insert into the battery compartment.

Battery operation is only possible if the power plug has been removed from the power socket of the microscope beforehand.

11 Troubleshooting

Problem	Possible causes
Lamp does not burn	Mains plug not plugged in correctly
	No power available at the socket
	Lamp defective
Lamp burns out immediately	The prescribed lamp or power supply is not used
Field of vision is dark	Aperture diaphragm and/or field diaphragm are not open wide enough
Brightness cannot be adjusted	The brightness control is set incorrectly
	The condenser was not centered correctly
	The condenser is lowered too far
Field of vision is dark or not correct illuminated	The lens was not swiveled in correctly
	The beam path selector slide is in an intermediate position
	The object turret is not mounted correctly
	The condenser is not fitted correctly
	A lens is used that does not match the illumination range of the condenser
	The condenser was not centered correctly
	The luminous field diaphragm is closed too far
	The lamp is not mounted correctly
The field of vision of one eye does not match that of the other eye	The interpupillary distance is not set correctly
	The diopter setting was not made correctly
	Different eyepieces are used on the right and left
	The eyes are not used to microscopy

Problem	Possible causes
Blurred details / Bad picture	Aperture diaphragm is not open wide enough
	Condenser is lowered too far

Poor contrast/ Vignetted field of view	The objective does not belong to this microscope
	The front lens of the lens is dirty
	An immersion lens is used without immersion oil
	The immersion oil contains air bubbles
	The condenser is not centered
	The recommended immersion oil is not used
	Dirt / dust on the lens
	Dirt / dust on the front lens of the condenser
Dirt or dust in the field of vision	Dirt / dust on the eyepieces
	Dirt / dust on the front lens of the condenser
	Dirt / dust on the object
One side of the image is blurred	The table was not assembled correctly
	The lens is not correctly swiveled into the beam path
	The nosepiece is not mounted correctly
	The object rests with the top side facing down.
The picture flickers	The nosepiece is not correct mounted
	The lens is not mounted correctly swiveled into the beam path
	The condenser was not installed correctly centered
The coarse drive is difficult to turn	The rotary resistor brake is closed tightened

12 Service

If, despite studying these operating instructions, you still have questions about commissioning or operation, or if, contrary to expectations, a problem should occur, please contact your specialist dealer. The device may only be opened by trained service technicians authorized by KERN.

13 Power supply / battery operation

13.1 Mains connection

⚠ WARNING



The microscope may only be connected to the mains if the information on the microscope (sticker) and the local mains voltage are identical.



Important:

- Check the mains cable for damage before commissioning
- Ensure that the power supply unit does not come into contact with liquids
- The mains plug must be accessible at all times.



Risk of fire and explosion due to incorrect charging or defective battery



Fire or explosion can lead to serious injuries

- ⇒ Be sure to observe the information on rechargeable batteries and batteries in the Safety chapter.
- ⇒ Never recharge batteries. Only rechargeable batteries are suitable for recharging.

Optionally available in mains or battery operation

Mains operation:

- Connection to mains via mains adapter

Battery operation for mobile use:

- 3x 1.5V AA batteries

14 Maintenance, servicing and disposal



Disconnect the appliance from the power supply before carrying out any maintenance, cleaning or repair work.

14.1 Cleaning

The appliance must always be kept clean and regularly freed from dust. Before wiping the appliance when it gets wet, make sure that the power is switched off.

Glass components should preferably be wiped lightly with a lint-free cloth if they become dirty.

To wipe oil stains or fingerprints from lens surfaces, the lint-free cloth is moistened with a mixture of ether and alcohol (70/30 ratio) and then cleaned

Ether and alcohol must always be handled with care as they are highly flammable substances. It is therefore essential to keep them away from naked flames and electrical appliances that are switched on and off and only use them in well-ventilated rooms.

However, organic solutions of this type should not be used to clean other components of the appliance. This could cause changes to the paintwork. It is sufficient to use a neutral cleaning agent for this purpose.

Other cleaning agents for the optical components include

- Special cleaner for optical lenses
- Special optical cleaning cloths
- Bellows
- Brush

If handled correctly and checked regularly, the microscope will function smoothly for many years.

14.2 Maintenance and repair

Do not make any modifications to the device or install spare parts. Contact the manufacturer for repair or device inspection.

14.3 Waste disposal



Old appliances and accessories must not be disposed of with household waste.

The operator must dispose of the packaging and the device at the place of use in accordance with the applicable national or regional legislation. The device consists of various components and materials, such as

- Electronic components (printed circuit boards, electrical cables)
- Plastic (housing)
- Metal

Improper disposal of the appliance can have harmful effects on people and the environment.

Proper and environmentally friendly disposal can prevent harmful effects and recover raw materials.

Disposal of rechargeable batteries and batteries:

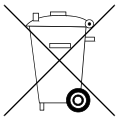

Rechargeable batteries and batteries do not belong in household waste.

The disposal of rechargeable batteries and batteries must be carried out by the operator in accordance with the applicable national or regional law of the place of use.

15 Battery law

Note in accordance with the Battery Act - BattG:

INFORMATION



- The following information is valid for Germany.

In connection with the sale of batteries and rechargeable batteries, we are obliged as a dealer under the Battery Act to inform end users of the following:

- End users are legally obliged to return used batteries and rechargeable batteries.
- Batteries and rechargeable batteries can be returned free of charge to municipal collection points or retailers after use. The normal end of use of the batteries/rechargeable batteries must be reached, otherwise precautions against short circuits must be taken.
- The return option is limited to batteries and rechargeable batteries of the type that we carry or have carried in our range and to the quantity that end consumers usually dispose of.
- A crossed-out waste garbage can means that you must not dispose of batteries or rechargeable batteries in household waste under any circumstances. Old batteries or rechargeable batteries may contain harmful substances that can damage people and the environment if not disposed of correctly.

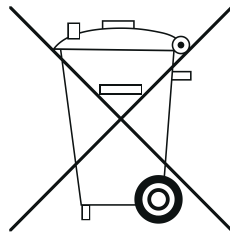

- Batteries containing harmful substances are marked with a symbol consisting of a crossed-out dustbin and the chemical symbol (Cd = cadmium, Hg = mercury, or Pb = lead) of the heavy metal responsible for the classification as containing harmful substances.

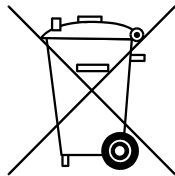

Cd

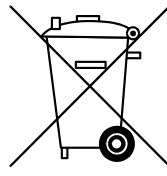

Hg

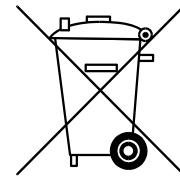

Pb

16 Further information

The illustrations may differ slightly from the product.

The descriptions and illustrations in these operating instructions are subject to change without notice. Further developments to the device may result in such changes.



All language versions include a non-binding translation.
The original German document is binding.